



190 OAKLAND ST.
RICHLAND, WA 99352
PHONE: (509) 736-7552

POLE BUILDING SKETCH

PLEASE INDICATE:

- BAY/POST SPACING 10' / 12' / OTHER _____
- PREFERRED POST LOCATIONS _____
- DOOR AND WINDOW LOCATIONS _____
- DOOR SWINGS _____
- OVERHANG LOCATIONS _____
- CONCRETE SLAB LIMITS _____
- BUILDING DIMENSIONS _____

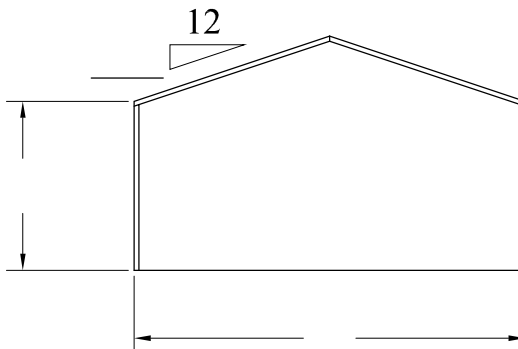
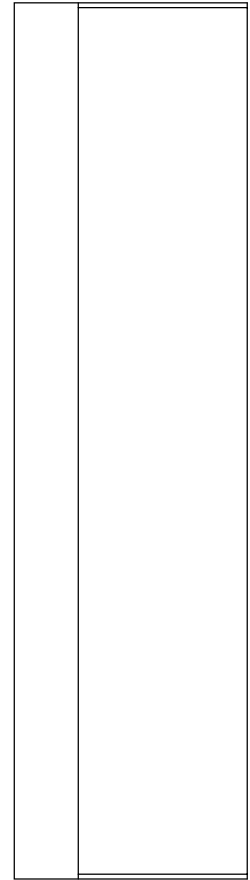
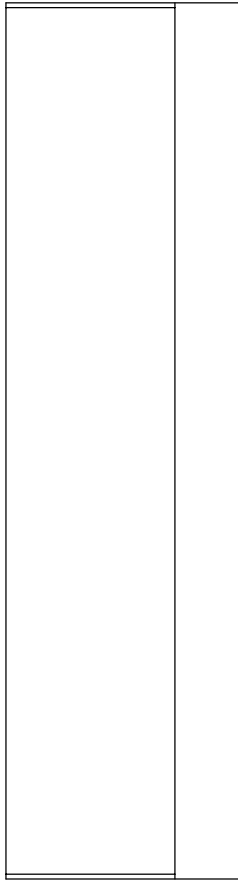
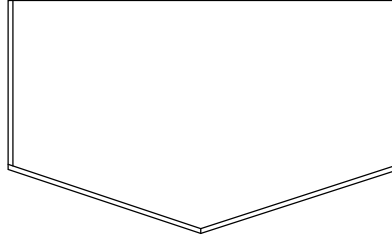



190 OAKLAND ST.
RICHLAND, WA 99352
PHONE: (509) 736-7552

POLE BUILDING SKETCH

PLEASE INDICATE:

- BAY/POST SPACING 10' / 12' / OTHER _____
- PREFERRED POST LOCATIONS
- DOOR AND WINDOW LOCATIONS
- DOOR SWINGS
- OVERHANG LOCATIONS
- CONCRETE SLAB LIMITS
- BUILDING DIMENSIONS

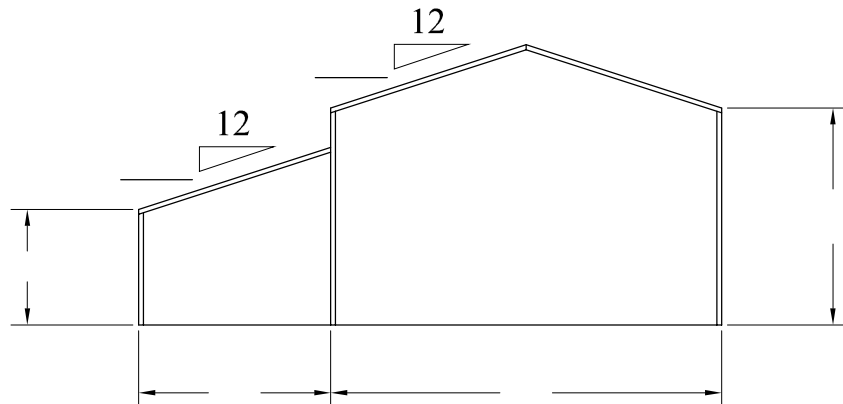
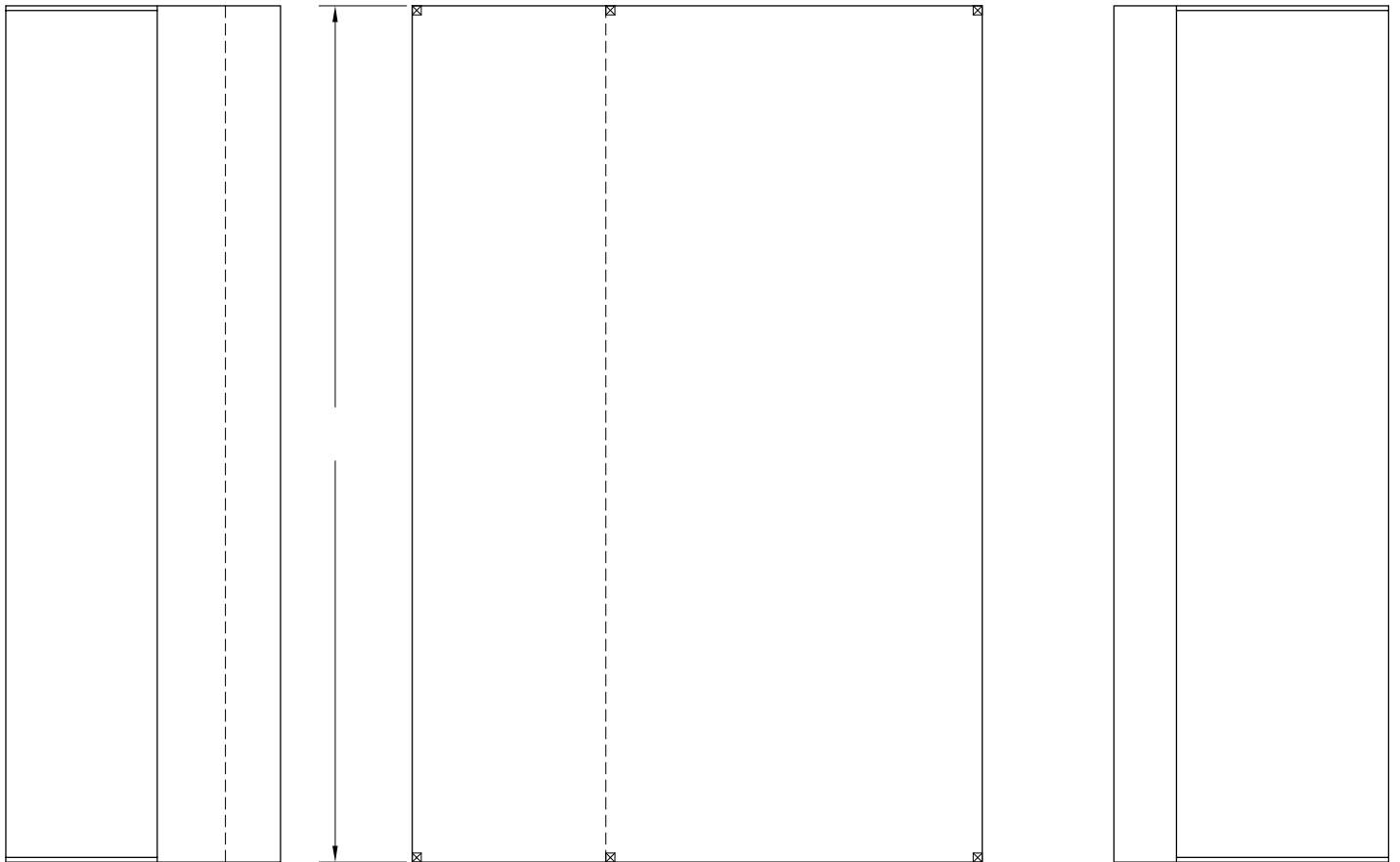
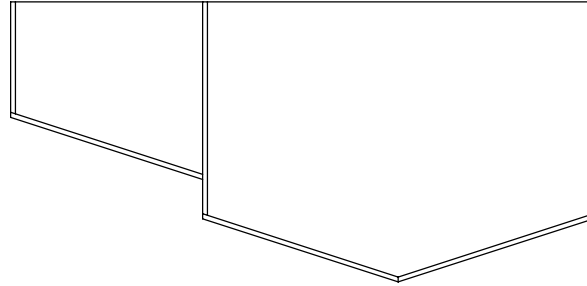



190 OAKLAND ST.
RICHLAND, WA 99352
PHONE: (509) 736-7552

PLEASE INDICATE:

- BAY/POST SPACING 10' / 12' / OTHER _____
- PREFERRED POST LOCATIONS
- DOOR AND WINDOW LOCATIONS
- DOOR SWINGS
- OVERHANG LOCATIONS
- CONCRETE SLAB LIMITS
- BUILDING DIMENSIONS

POLE BUILDING SKETCH

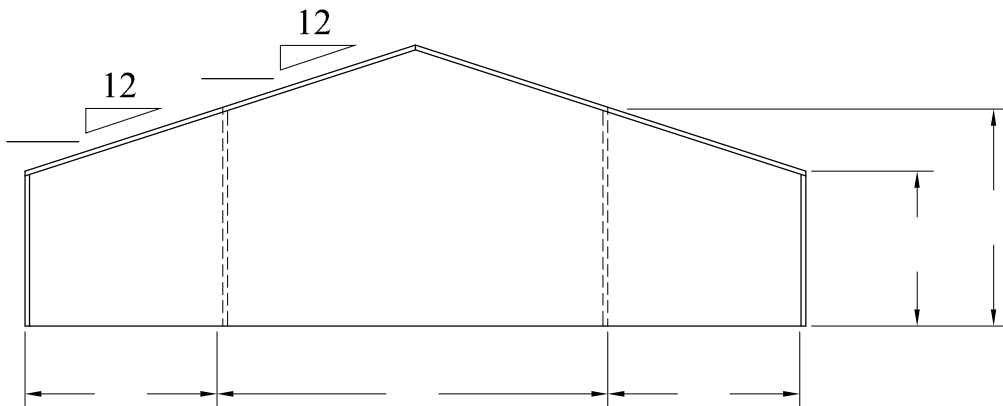
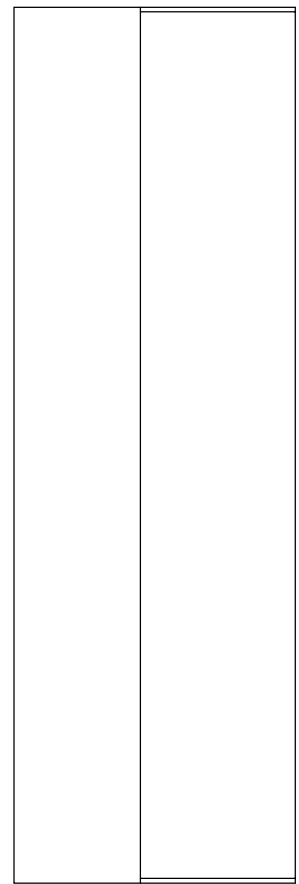
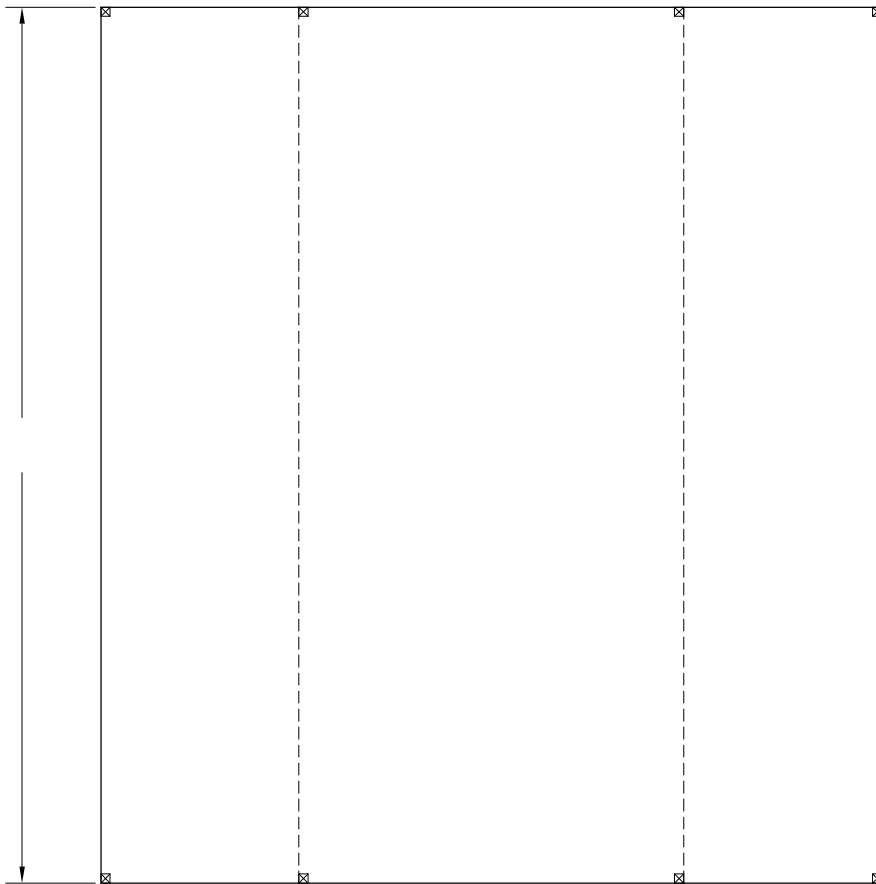
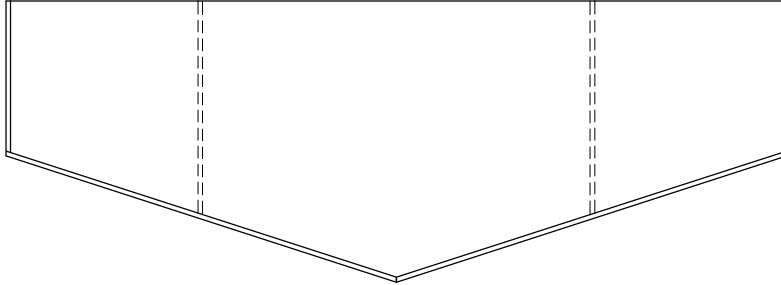



190 OAKLAND ST.
RICHLAND, WA 99352
PHONE: (509) 736-7552

POLE BUILDING SKETCH

PLEASE INDICATE:

- BAY/POST SPACING 10' / 12' / OTHER _____
- PREFERRED POST LOCATIONS
- DOOR AND WINDOW LOCATIONS
- DOOR SWINGS
- OVERHANG LOCATIONS
- CONCRETE SLAB LIMITS
- BUILDING DIMENSIONS

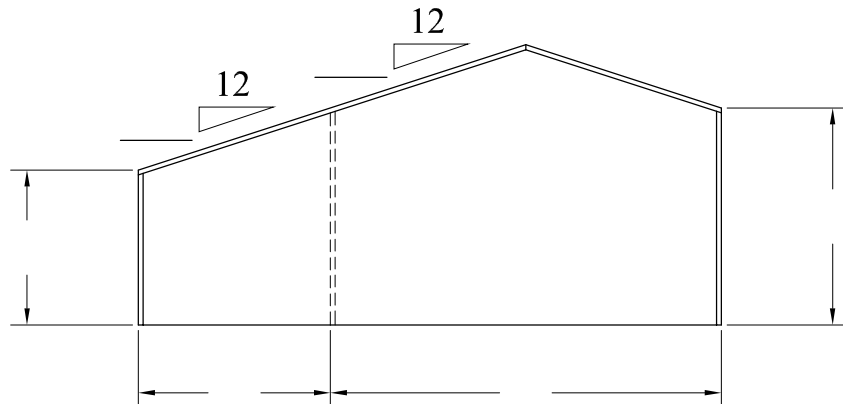
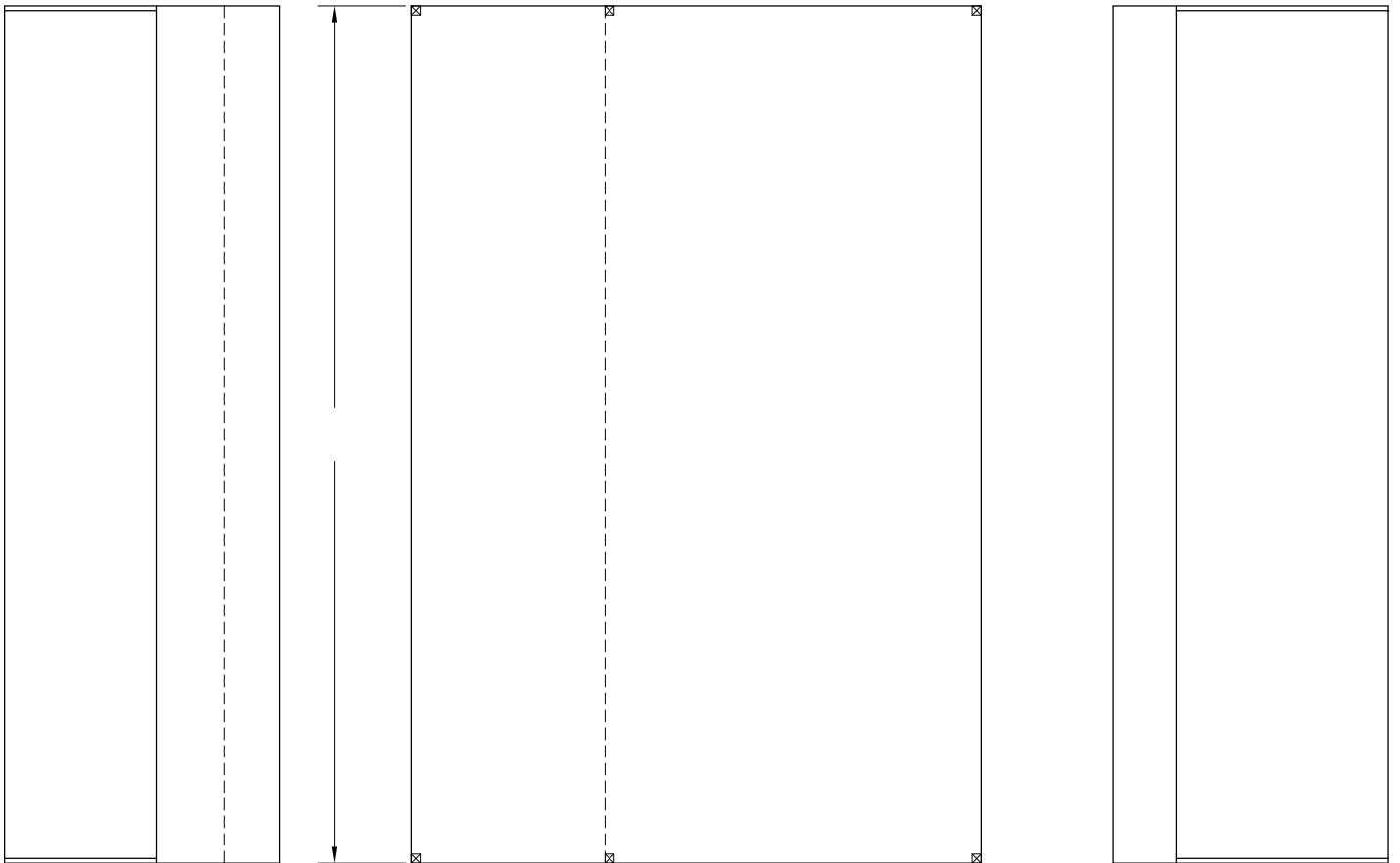
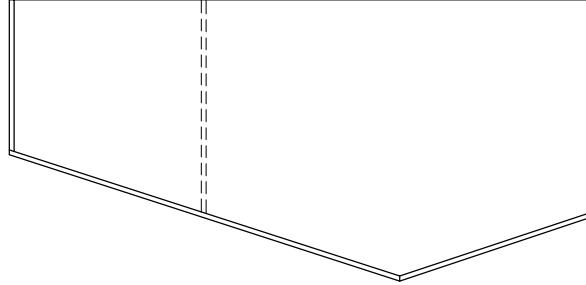



190 OAKLAND ST.
RICHLAND, WA 99352
PHONE: (509) 736-7552

PLEASE INDICATE:

- BAY/POST SPACING 10' / 12' / OTHER _____
- PREFERRED POST LOCATIONS
- DOOR AND WINDOW LOCATIONS
- DOOR SWINGS
- OVERHANG LOCATIONS
- CONCRETE SLAB LIMITS
- BUILDING DIMENSIONS

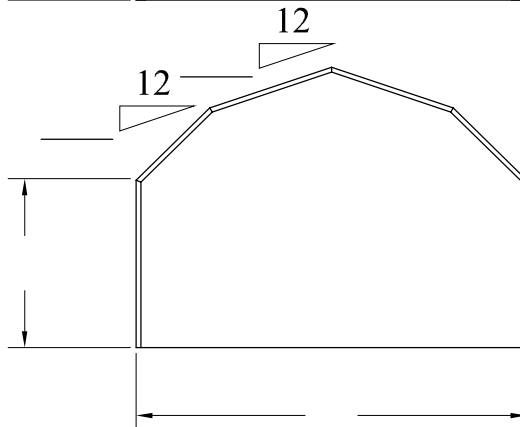
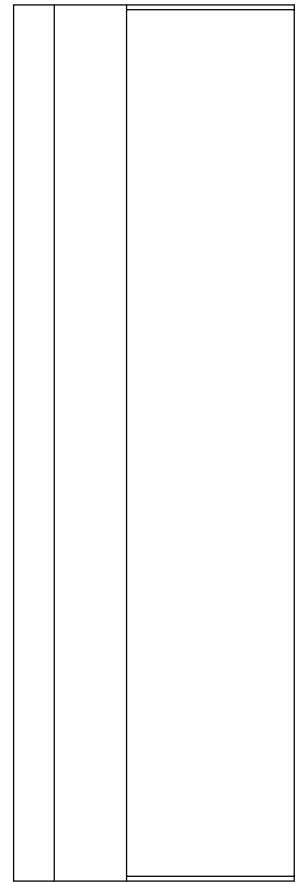
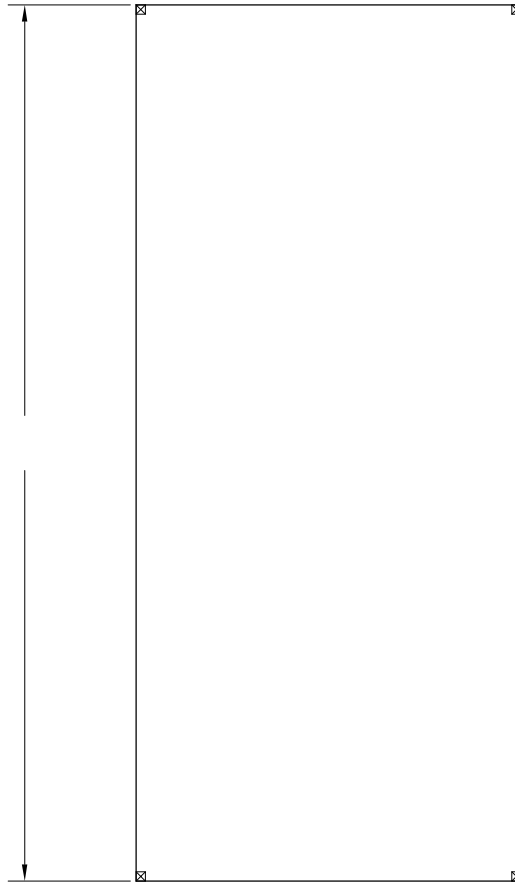
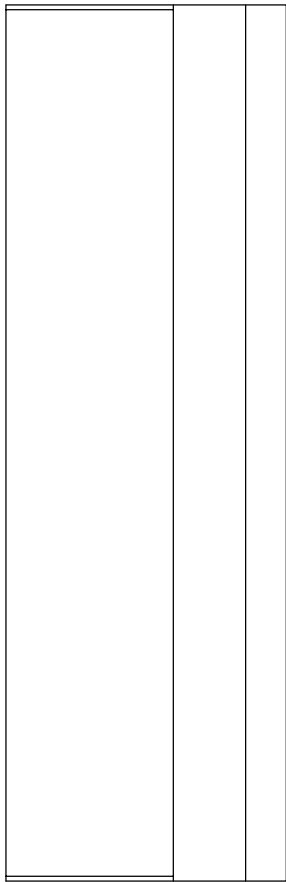
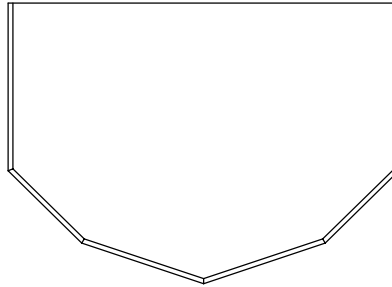



190 OAKLAND ST.
RICHLAND, WA 99352
PHONE: (509) 736-7552

PLEASE INDICATE:

- BAY/POST SPACING 10' / 12' / OTHER _____
- PREFERRED POST LOCATIONS
- DOOR AND WINDOW LOCATIONS
- DOOR SWINGS
- OVERHANG LOCATIONS
- CONCRETE SLAB LIMITS
- BUILDING DIMENSIONS

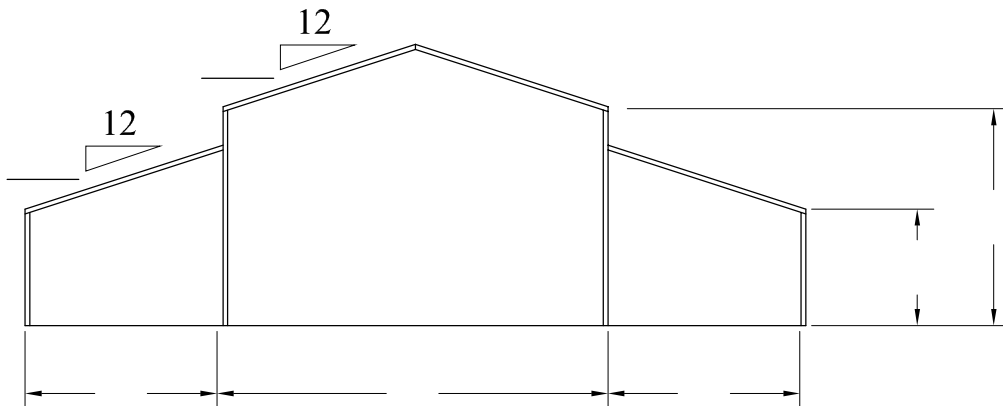
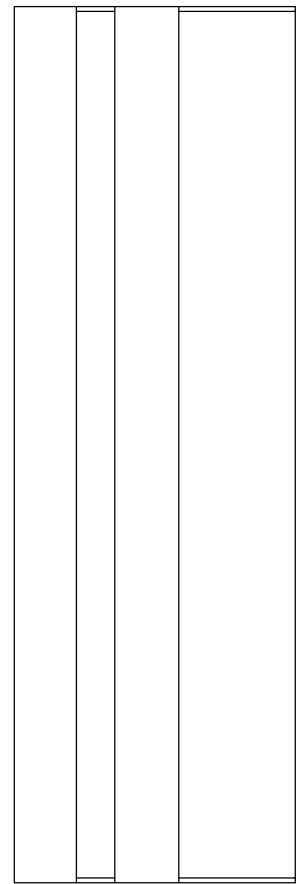
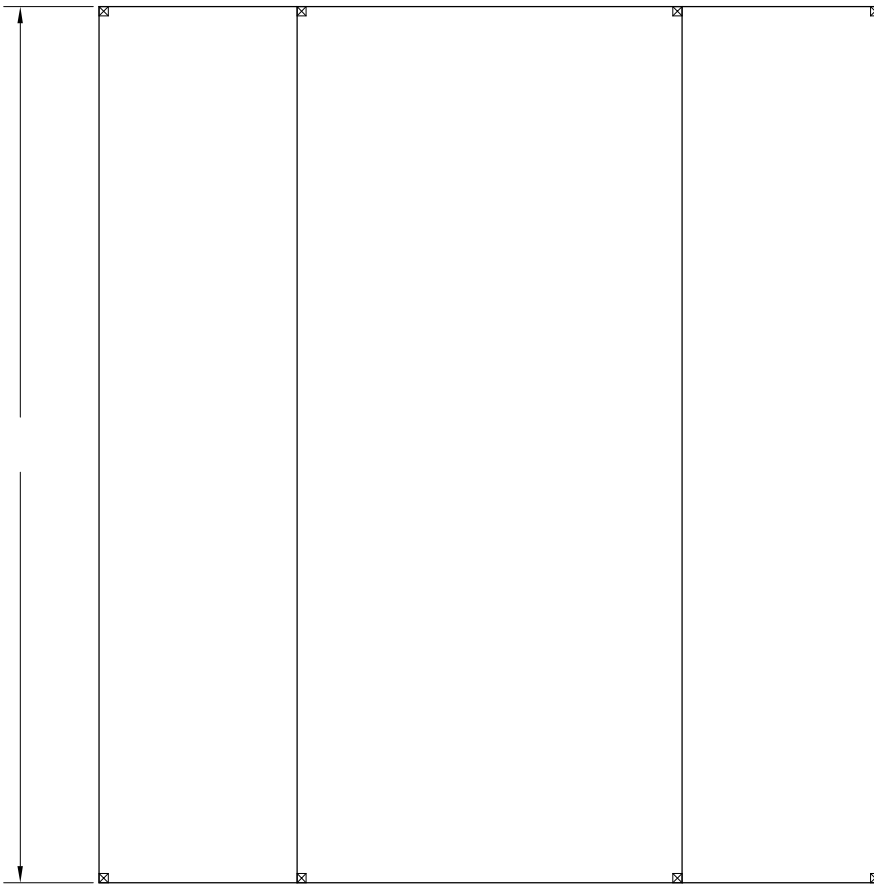
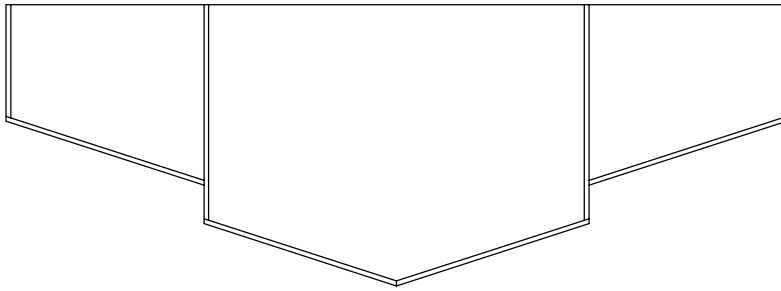



190 OAKLAND ST.
RICHLAND, WA 99352
PHONE: (509) 736-7552

POLE BUILDING SKETCH

PLEASE INDICATE:

- BAY/POST SPACING 10' / 12' / OTHER _____
- PREFERRED POST LOCATIONS
- DOOR AND WINDOW LOCATIONS
- DOOR SWINGS
- OVERHANG LOCATIONS
- CONCRETE SLAB LIMITS
- BUILDING DIMENSIONS

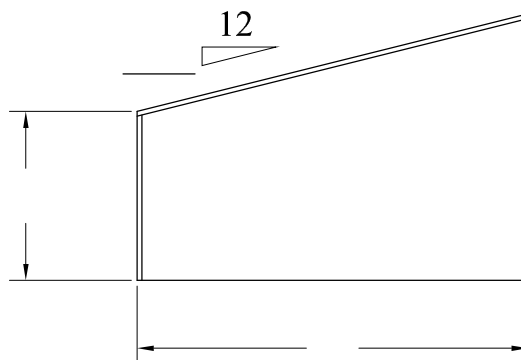
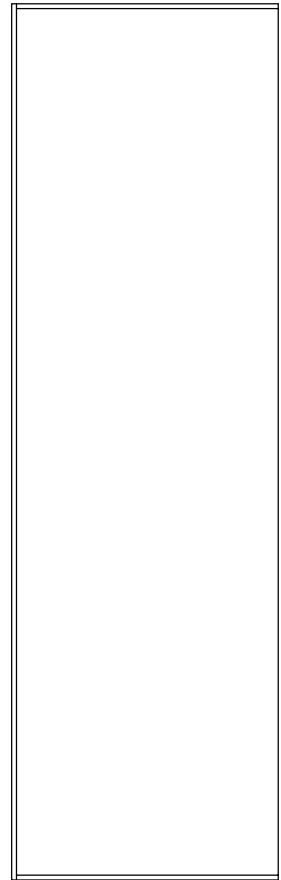
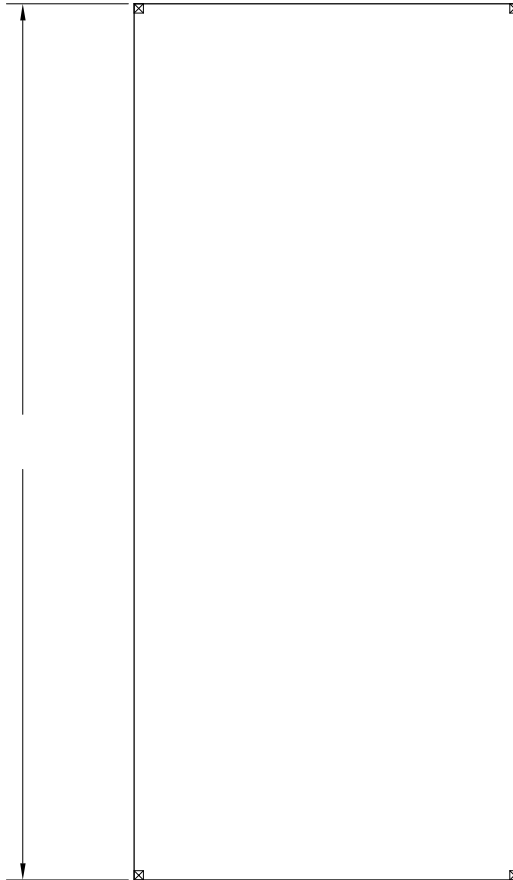
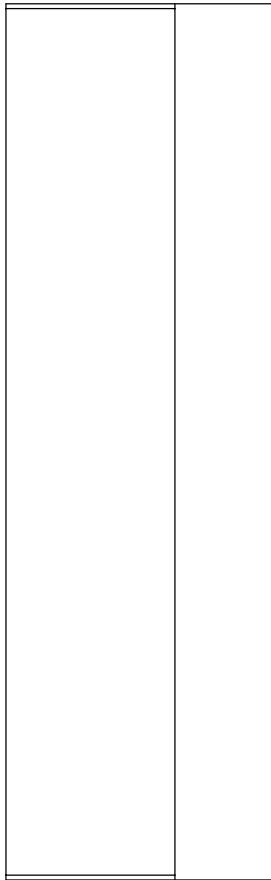
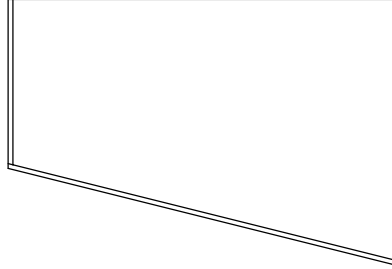



190 OAKLAND ST.
RICHLAND, WA 99352
PHONE: (509) 736-7552

POLE BUILDING SKETCH

PLEASE INDICATE:

- BAY/POST SPACING 10' / 12' / OTHER _____
- PREFERRED POST LOCATIONS
- DOOR AND WINDOW LOCATIONS
- DOOR SWINGS
- OVERHANG LOCATIONS
- CONCRETE SLAB LIMITS
- BUILDING DIMENSIONS

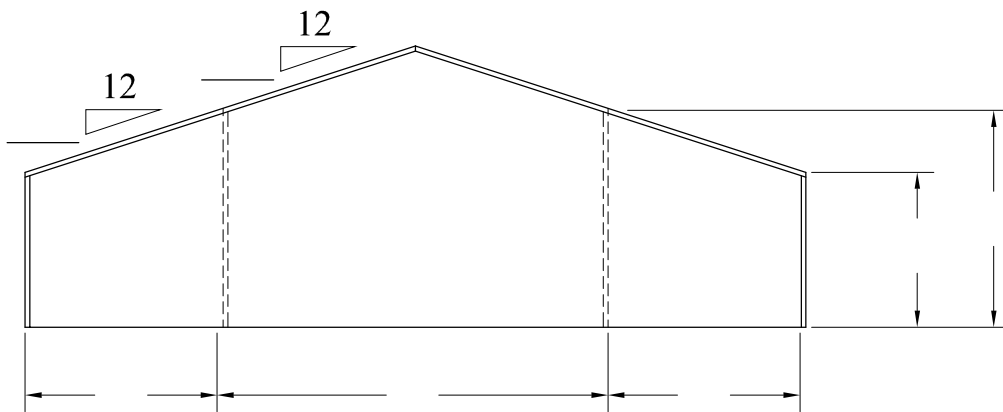
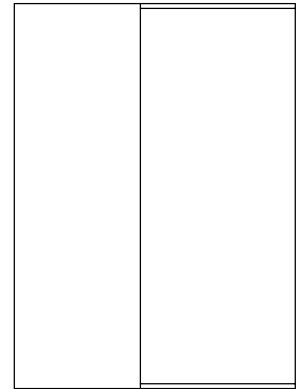
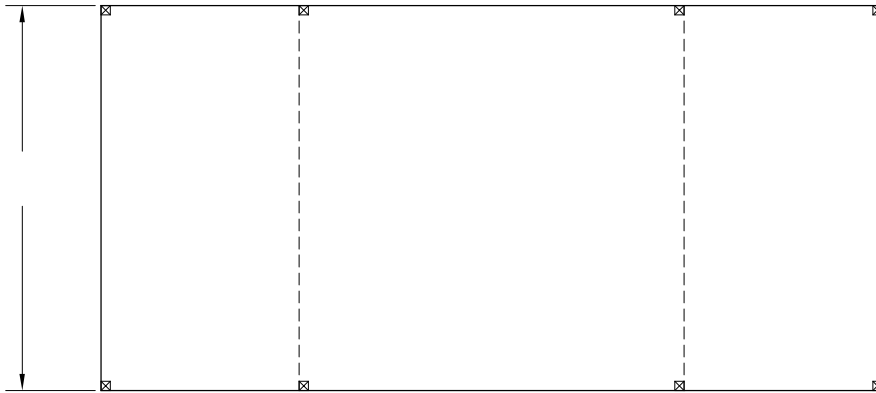
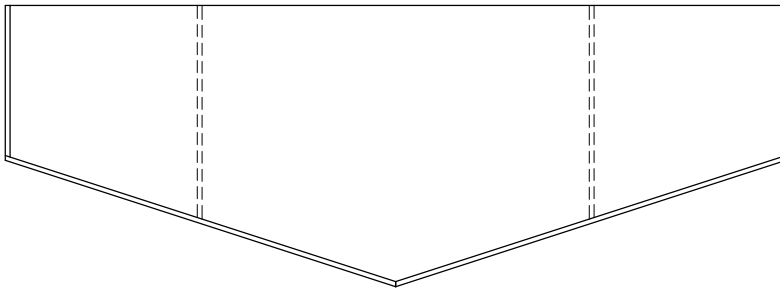



190 OAKLAND ST.
RICHLAND, WA 99352
PHONE: (509) 736-7552

POLE BUILDING SKETCH

PLEASE INDICATE:

- BAY/POST SPACING 10' / 12' / OTHER _____
- PREFERRED POST LOCATIONS
- DOOR AND WINDOW LOCATIONS
- DOOR SWINGS
- OVERHANG LOCATIONS
- CONCRETE SLAB LIMITS
- BUILDING DIMENSIONS

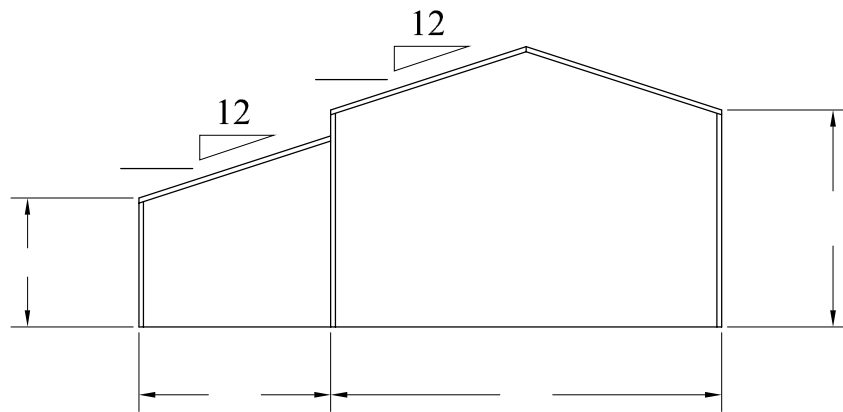
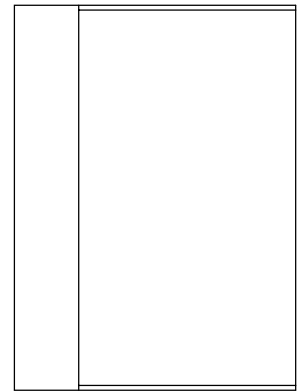
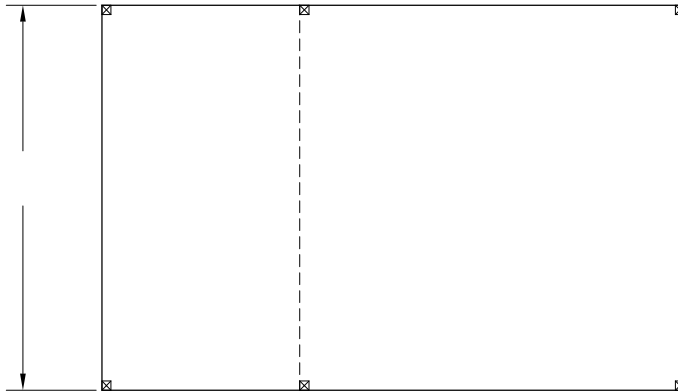
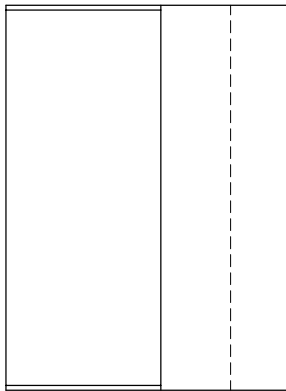
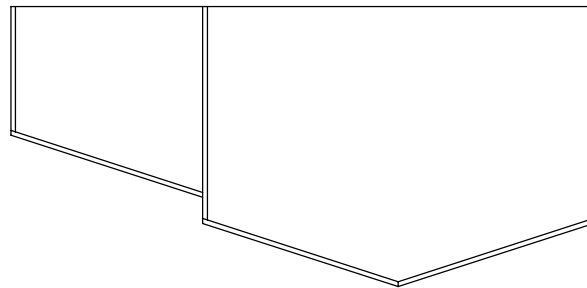



190 OAKLAND ST.
RICHLAND, WA 99352
PHONE: (509) 736-7552

POLE BUILDING SKETCH

PLEASE INDICATE:

- BAY/POST SPACING 10' / 12' / OTHER _____
- PREFERRED POST LOCATIONS
- DOOR AND WINDOW LOCATIONS
- DOOR SWINGS
- OVERHANG LOCATIONS
- CONCRETE SLAB LIMITS
- BUILDING DIMENSIONS

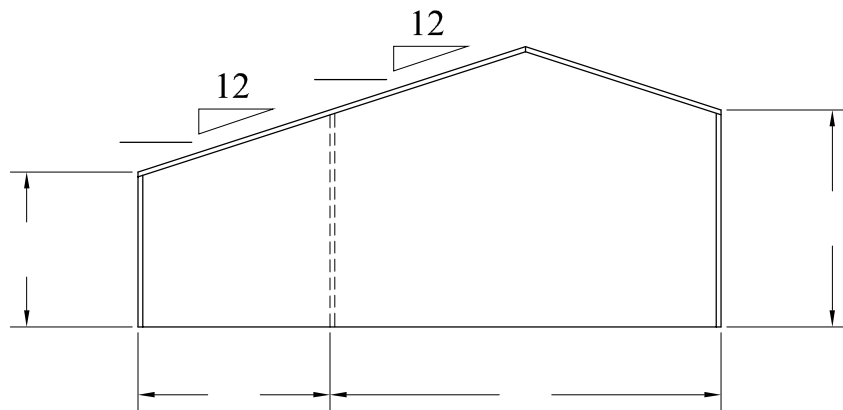
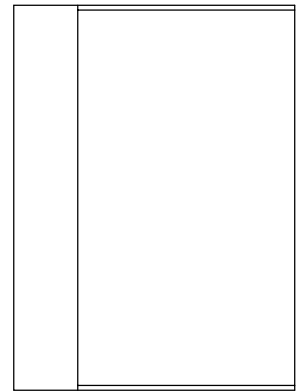
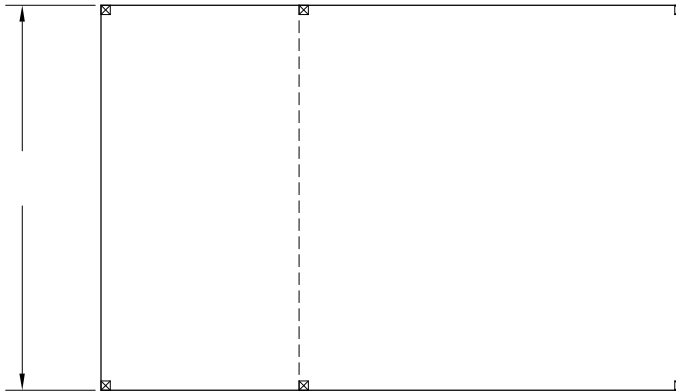
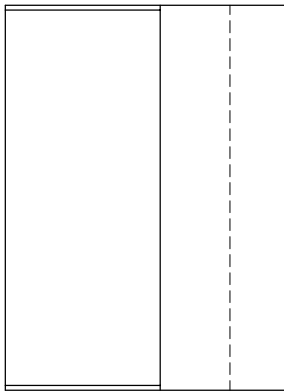
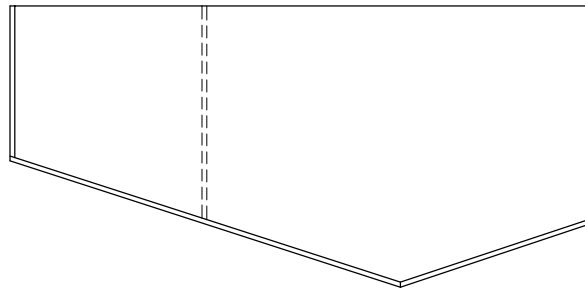



190 OAKLAND ST.
RICHLAND, WA 99352
PHONE: (509) 736-7552

POLE BUILDING SKETCH

PLEASE INDICATE:

- BAY/POST SPACING 10' / 12' / OTHER _____
- PREFERRED POST LOCATIONS
- DOOR AND WINDOW LOCATIONS
- DOOR SWINGS
- OVERHANG LOCATIONS
- CONCRETE SLAB LIMITS
- BUILDING DIMENSIONS

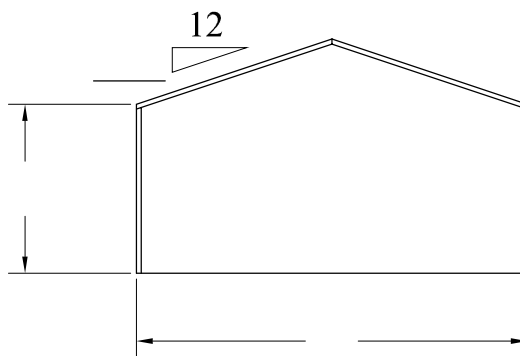
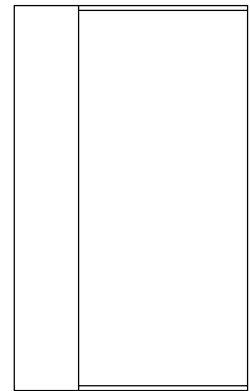
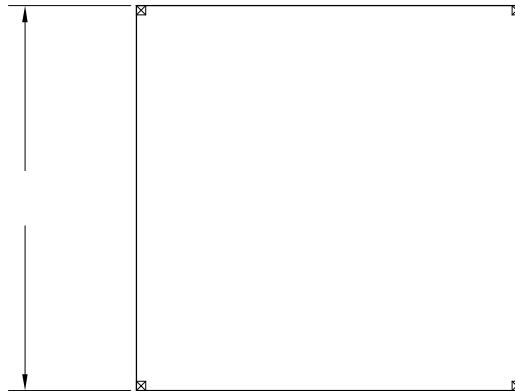
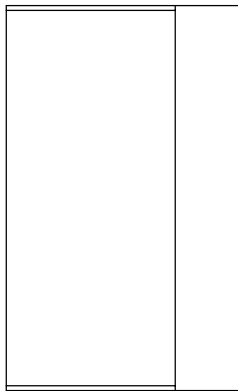
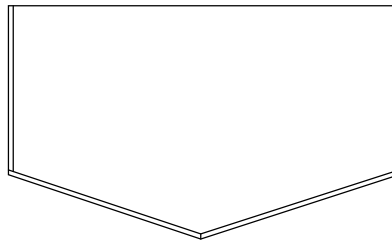



190 OAKLAND ST.
RICHLAND, WA 99352
PHONE: (509) 736-7552

PLEASE INDICATE:

- BAY/POST SPACING 10' / 12' / OTHER _____
- PREFERRED POST LOCATIONS _____
- DOOR AND WINDOW LOCATIONS _____
- DOOR SWINGS _____
- OVERHANG LOCATIONS _____
- CONCRETE SLAB LIMITS _____
- BUILDING DIMENSIONS _____

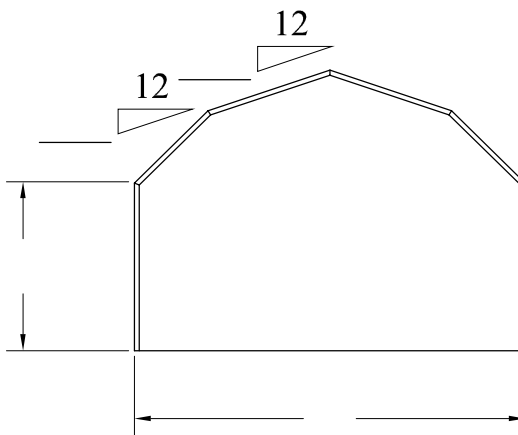
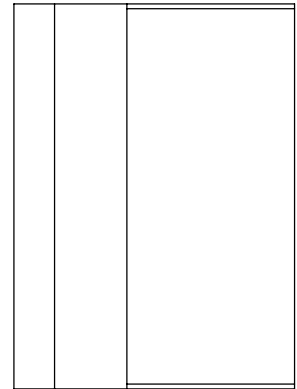
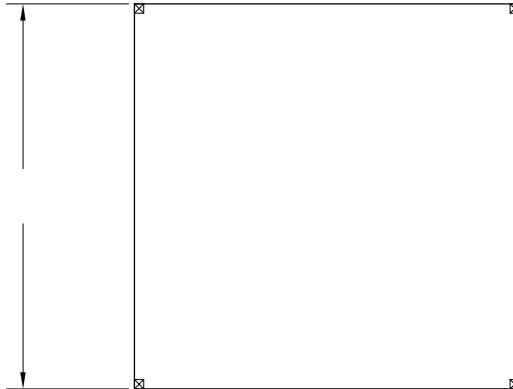
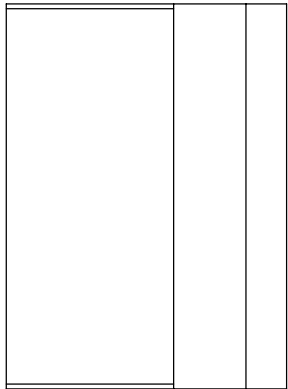
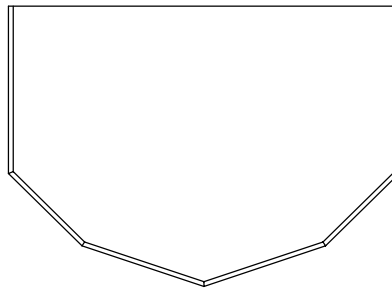



190 OAKLAND ST.
RICHLAND, WA 99352
PHONE: (509) 736-7552

PLEASE INDICATE:

- BAY/POST SPACING 10' / 12' / OTHER _____
- PREFERRED POST LOCATIONS
- DOOR AND WINDOW LOCATIONS
- DOOR SWINGS
- OVERHANG LOCATIONS
- CONCRETE SLAB LIMITS
- BUILDING DIMENSIONS

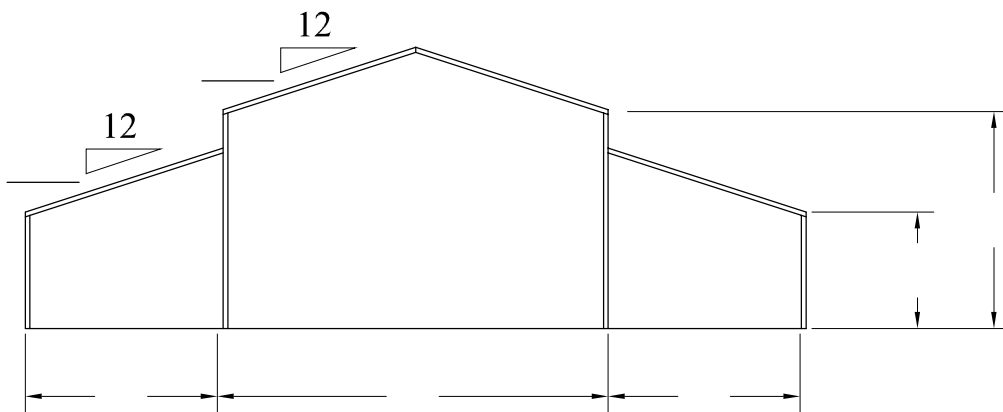
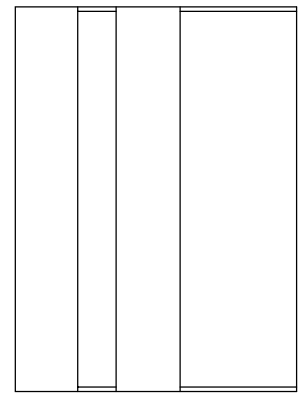
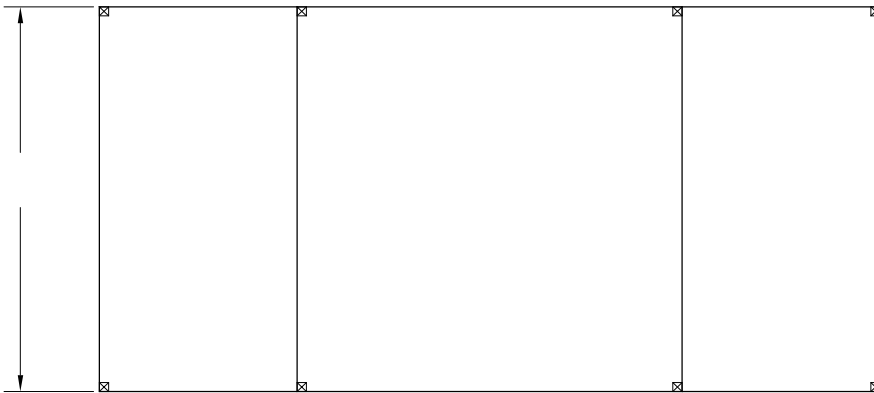
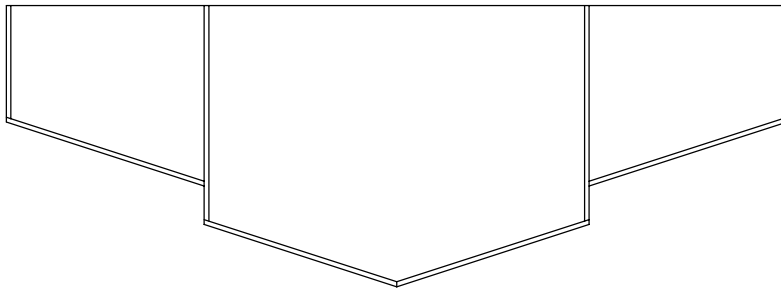



190 OAKLAND ST.
RICHLAND, WA 99352
PHONE: (509) 736-7552

POLE BUILDING SKETCH

PLEASE INDICATE:

- BAY/POST SPACING 10' / 12' / OTHER _____
- PREFERRED POST LOCATIONS
- DOOR AND WINDOW LOCATIONS
- DOOR SWINGS
- OVERHANG LOCATIONS
- CONCRETE SLAB LIMITS
- BUILDING DIMENSIONS

